

1. Fix the low rigidity ladders D on the panels A and B with the help of the bolts O.  
 Fix the stiffeners E and F on the ladders D and on the panels A and B using the bolts M and the bolts T.  
 Insert the tubes of the panels A and B into the tubes of the truss C  
 Fix Trusses C in the Panels A and B using Bolts U  
 Insert the L wood slats (17 per panel) into the slides of panels A and B

2. Fix the purlins I and J on the trusses C using the P bolts.

3. Position the steel roof sheet H on the purlins I and J  
 Fix the sheets H on the purlins J using the set R N S on all the long waves  
 Position the ridge tile G on the sheets H  
 Fix the ridge tile G between them using self-drilling screws Q  
 Fix the ridge G and the sheet H on the purlins J using the R and S set.

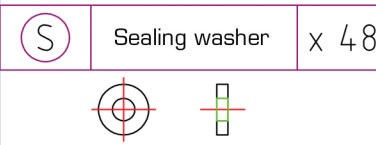
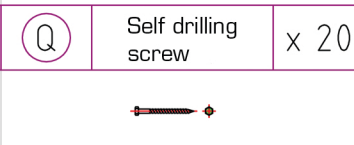
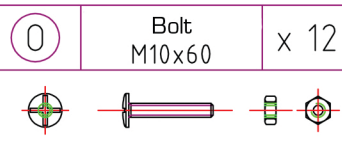
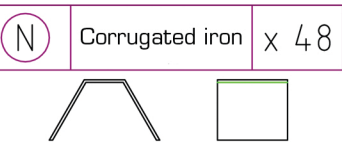
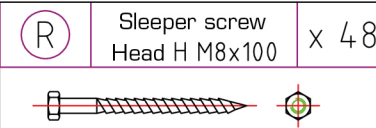
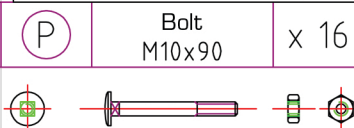
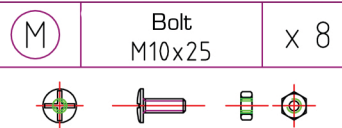
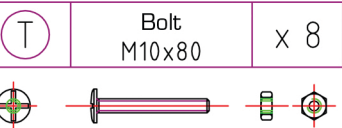
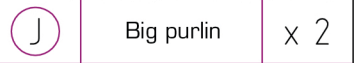
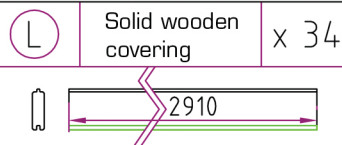
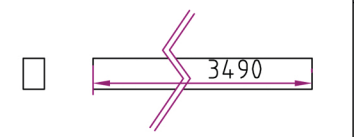
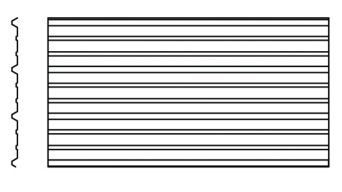
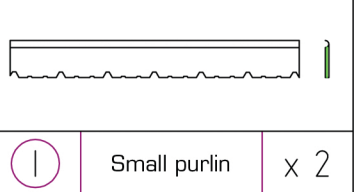
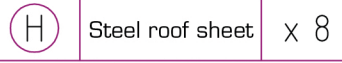
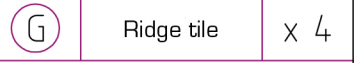
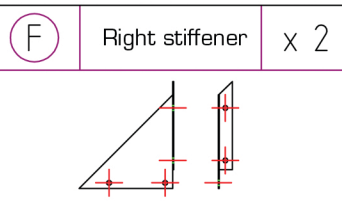
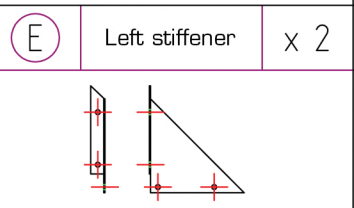
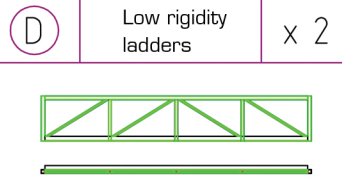
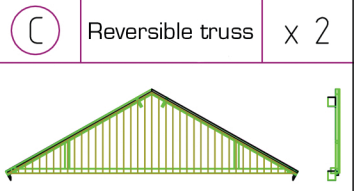
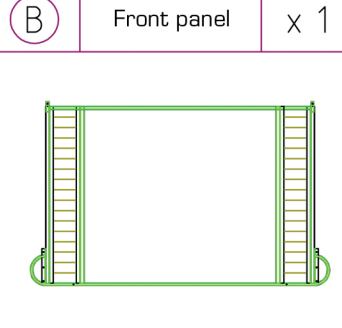
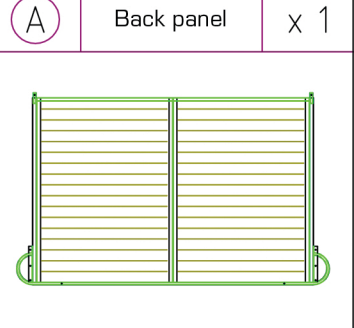
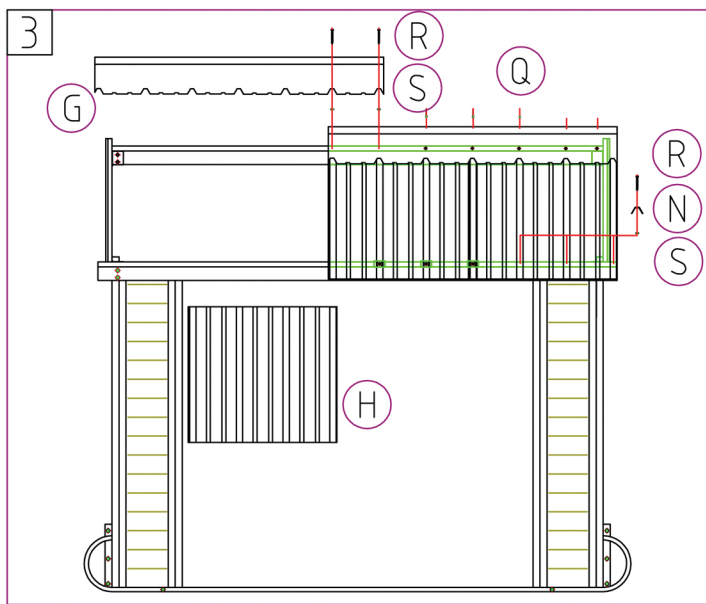
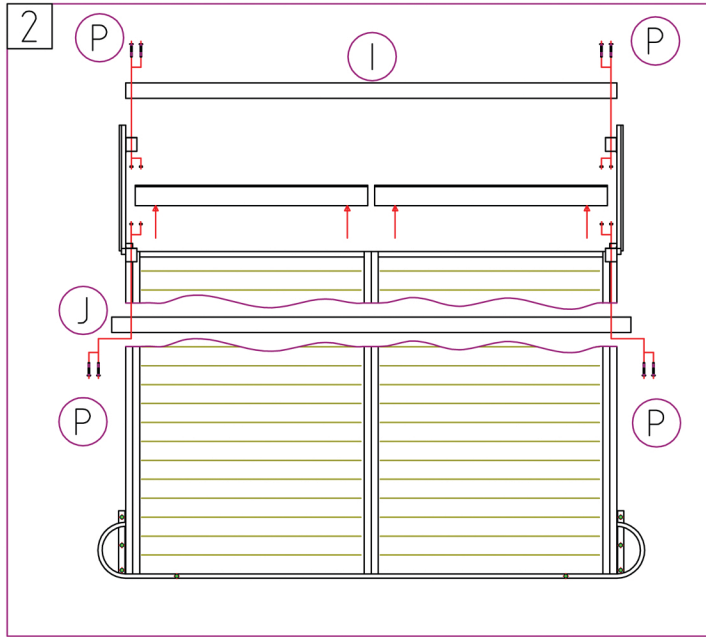
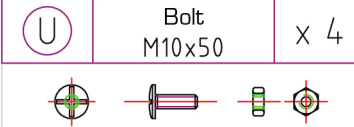

EQUIP'HORSE  
 RD 613 - MAROLLES  
 14100 LISIEUX  
 Tél.. : 02 31 63 68 65

MOVABLE SHELTER instructions  
 DATE : 05/04/2013 REVISION : A  
 PAGE : 1/1 FORMAT : A3 REF : -